

DATA SHEET

SKY65116: 390 to 500 MHz Linear Power Amplifier

Applications

- TETRA radio
- GSM450 and GSM480
- NMT450
- Wireless local loop

Features

- Wideband frequency operation: 390 to 500 MHz
- High linearity: OIP3 +43 dBm
- High efficiency: 40% PAE
- High gain: 35 dB
- P1dB = +32.5 dBm
- Single DC supply: 3.6 V
- Internal RF match and bias circuits
- PA on/off voltage control
- Operating temperature: -40 °C to +85 °C
- Low cost, MCM (12-pin, 8 x 8 mm) Pb-free (MSL3, 250 °C per JEDEC J-STD-020) package



Skyworks Green™ products are compliant with all applicable legislation and are halogen-free. For additional information, refer to *Skyworks Definition of Green™*, document number SQ04-0074.

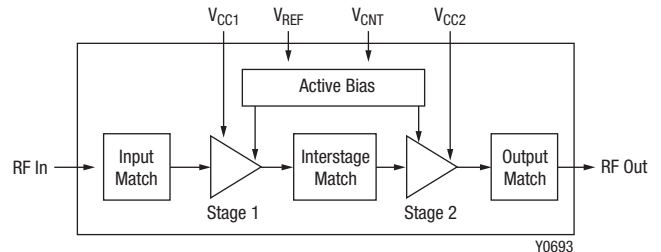

Figure 1. SKY65116 Functional Block Diagram

Description

The SKY65116 is a fully matched, linear Power Amplifier (PA), high linearity and high efficiency surface mount module designed for use in the 390 to 500 MHz band.

The device is fabricated using Skyworks high reliability Gallium Arsenide (GaAs) Heterojunction Bipolar Transistor (HBT) process, which allows for single supply operation while maintaining high efficiency and good linearity. Microwave Monolithic Integrated Circuits (MMICs), comprised of GaAs and Silicon CMOS, contain all the active circuitry in the module. This includes the in-module bias circuitry, as well as the RF interstage matching circuit. The input and output match is realized off-chip within the module package to optimize efficiency and high power performance ($P_{1\text{dB}} = +32.5\text{ dBm}$) into a $50\ \Omega$ load.

Primary bias to the SKY65116 can be supplied directly from a single cell lithium-ion or other suitable battery with a nominal output of 3.6 V. No external supply side switch is needed as typical “off” leakage is a few microamperes with full primary voltage supplied from the battery.

The module can operate over the temperature range of -40 °C to +85 °C.

The SKY65116 is provided in a low-cost, Surface Mount Technology (SMT) 8 x 8 mm Multi-Chip Module (MCM) package. Figure 1 shows a functional block diagram for the SKY65116. The pin configuration and package are shown in Figure 2. Signal pin assignments and functional pin descriptions are provided in Table 1.

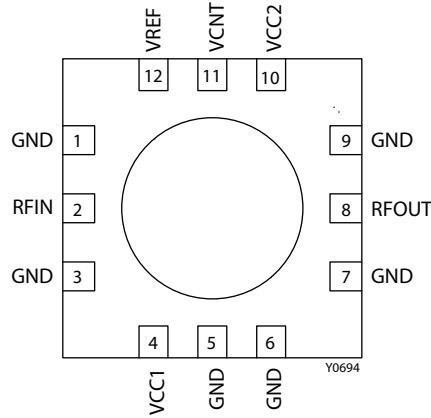

Figure 2. SKY65116 Pinout– 12-Pin MCM Package

Table 1. SKY65116 Signal Descriptions

Pin	Name	Description	Pin	Name	Description
1	GND	Ground	7	GND	Ground
2	RFIN	RF input	8	RFOUT	RF output
3	GND	Ground	9	GND	Ground
4	VCC1	Stage 1 collector voltage	10	VCC2	Stage 2 collector voltage
5	GND	Ground	11	VCNT	PA on/off control voltage
6	GND	Ground	12	VREF	Bias reference voltage

Technical Description

The SKY65116 is comprised of two amplifier stages. The matching circuits for the input stage, inter-stage, and output stage are contained within the device. The bias circuits for both input and output stages are included within the device for optimum temperature tracking performance.

The SKY65116 is internally matched for optimum linearity and efficiency. The input and output stages are independently supplied using the VCC1 and VCC2 supply lines, pins 4 and 10, respectively. The bias reference voltage is supplied using a common VREF (pin 12) line. The device can be switched on and off using the VCNT signal (pin 11).

Electrical and Mechanical Specifications

The absolute maximum ratings of the SKY65116 are provided in Table 2. The recommended operating conditions are specified in Table 3 and electrical specifications are provided in Table 4.

Typical performance characteristics over temperature of the SKY65116 are illustrated in Figures 3 through 29.

Figure 34 shows the package dimensions for the 12-pin SKY65116 MCM and Figure 35 provides the tape and reel dimensions.

Table 2. SKY65116 Absolute Maximum Ratings (Note 1)

Parameter	Symbol	Min	Typical	Max	Units
RF output power	P _{OUT}			+34.5	dBm
Supply voltage	V _{CC1} , V _{CC2} , V _{REF} , V _{CNT}			4.5	V
Supply current	I _{CC}			1300	mA
Power dissipation	P _{DISS}			3.7	W
Case operating temperature	T _C	-40		+85	°C
Storage temperature	T _{ST}	-55		+125	°C
Junction temperature	T _J			+150	°C

Note 1: Exposure to maximum rating conditions for extended periods may reduce device reliability. There is no damage to device with only one parameter set at the limit and all other parameters set at or below their nominal values.

CAUTION: Although this device is designed to be as robust as possible, Electrostatic Discharge (ESD) can damage this device. This device must be protected at all times from ESD. Static charges may easily produce potentials of several kilovolts on the human body or equipment, which can discharge without detection. Industry-standard ESD precautions should be used at all times.

Table 3. SKY65116 Recommended Operating Conditions

Parameter	Symbol	Min	Typical	Max	Units
Supply voltage	V _{CC}	3.2	3.6	4.0	V
Reference voltage	V _{REF}	3.2	3.6	4.0	V
Control voltage (power-up)	V _{CNT}	2.7	3.6		V
Control voltage (power down)	V _{CNT}		0	0.5	V
Operating frequency	f	390		500	MHz
Operating case temperature	T _C	-40	+25	+85	°C

Table 4. SKY65116 Electrical Characteristics
(VCC1 = VCC2 = VCNT = VREF = 3.6 V, Tc = +25 °C, Z0 = 50 Ω, Unless Otherwise Specified)

Parameter	Symbol	Test Condition	Min	Typical	Max	Units
Frequency	F		390		500	MHz
Quiescent current	I _Q	No RF	0.1	0.33	0.375	A
Small signal gain	G	P _{IN} = -15 dBm	33.5	35		dB
Input return loss	S ₁₁	P _{IN} = -15 dBm	10	22		dB
Output return loss	S ₂₂	P _{IN} = -15 dBm	4.5	6		dB
Output power	P _{OUT}	@ P _{1 dB}	31.5	32.5		dBm
Power added efficiency	PAE	P _{OUT} @ P _{1 dB}	35	42		%
Output IP3	OIP3	P _{OUT} = 25 dBm/tone	38	43		dBm
Noise figure	NF	P _{IN} = -15 dBm		6	7.5	dB
Thermal resistance	Θ _{JC}	Junction to case		17.6		°C/W

Typical Performance Characteristics
(VCC1 = VCC2 = VCNT = VREF = 3.6 V, Tc = +25 °C, ZO = 50 Ω, Unless Otherwise Specified)

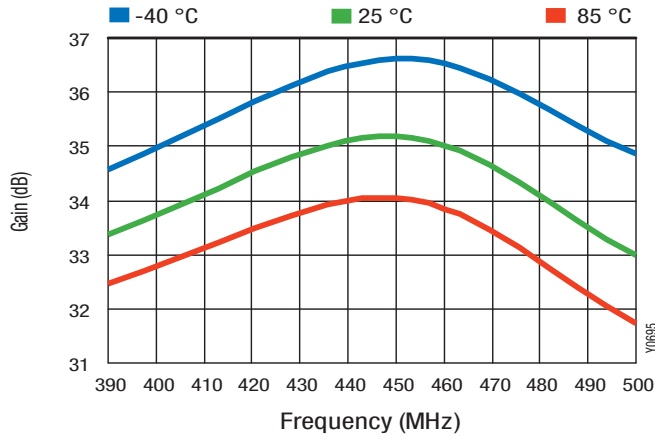

Figure 3. Gain vs Frequency Across Temperature

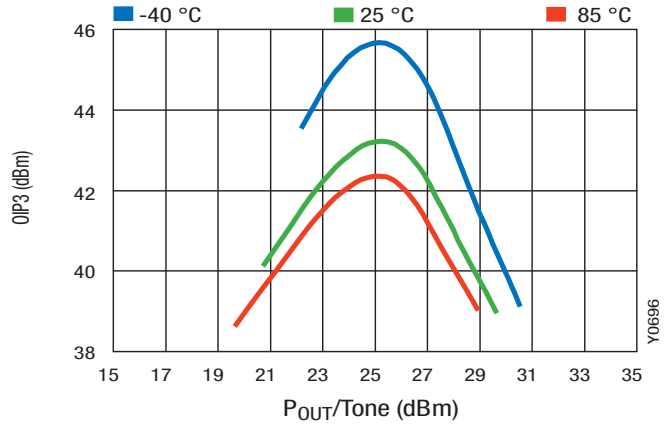

Figure 4. OIP3 vs Output Power /Tone Across Temperature

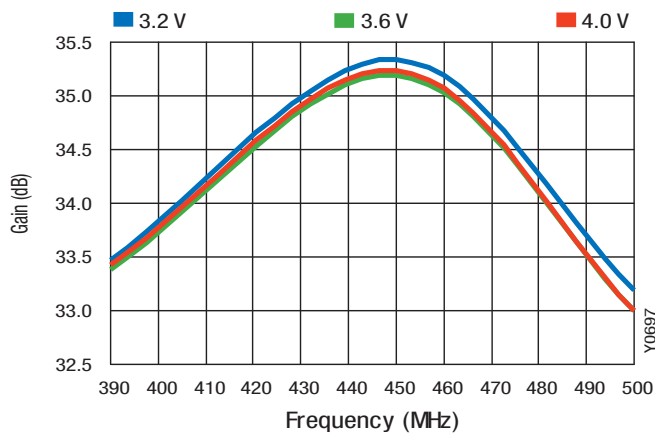

Figure 5. Gain vs Frequency Across Voltage

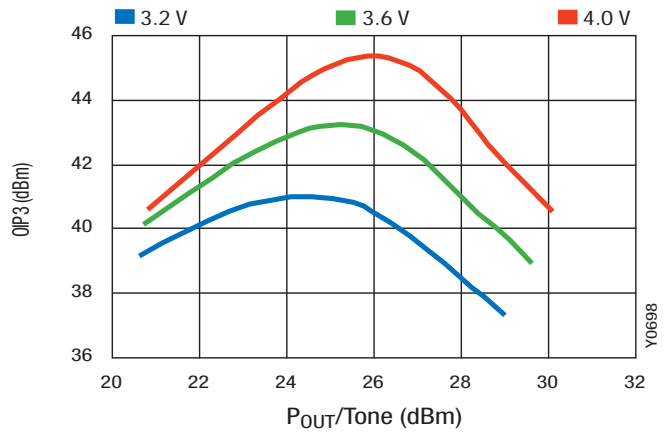

Figure 6. OIP3 vs Output Power /Tone Across Voltage

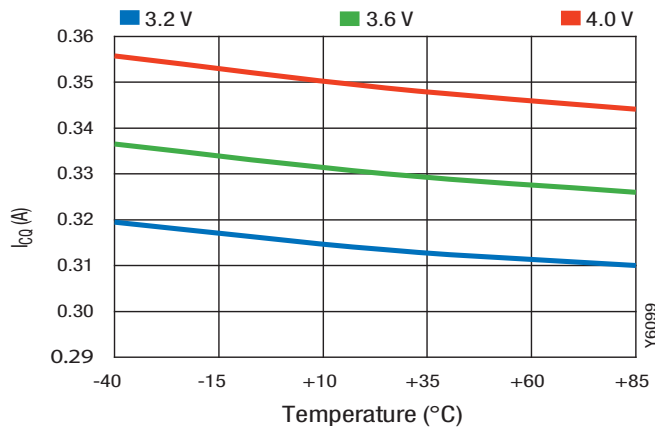

Figure 7. ICQ vs Temperature Across Voltage

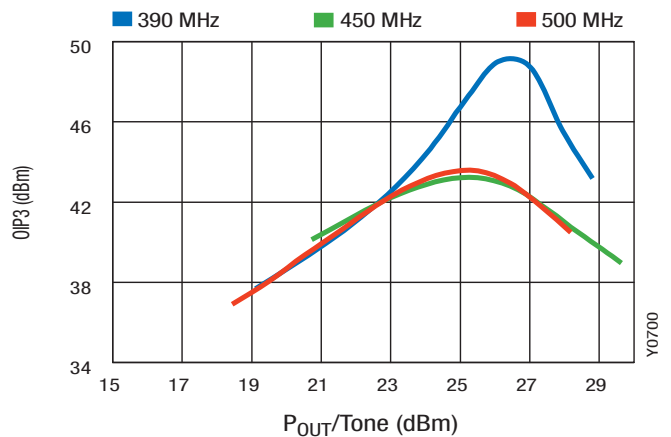

Figure 8. OIP3 vs Output Power/Tone Across Frequency

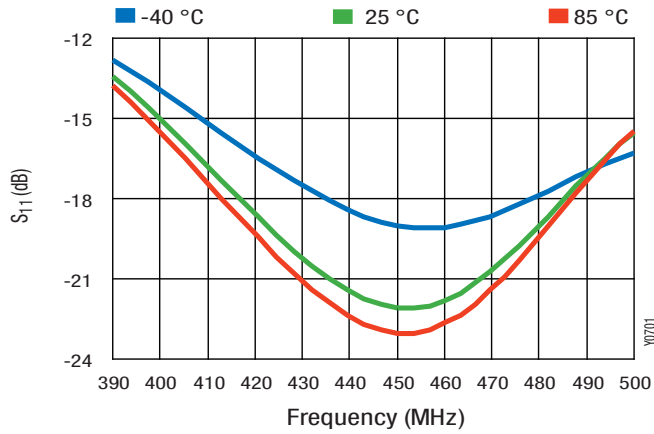

Figure 9. S11 vs Frequency Across Temperature

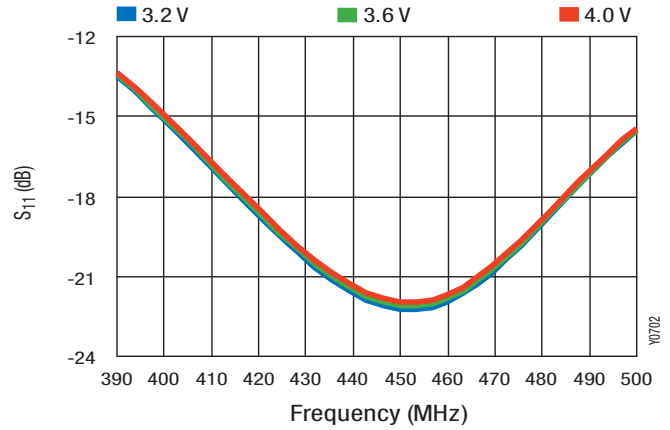

Figure 10. S11 vs Frequency Across VCC

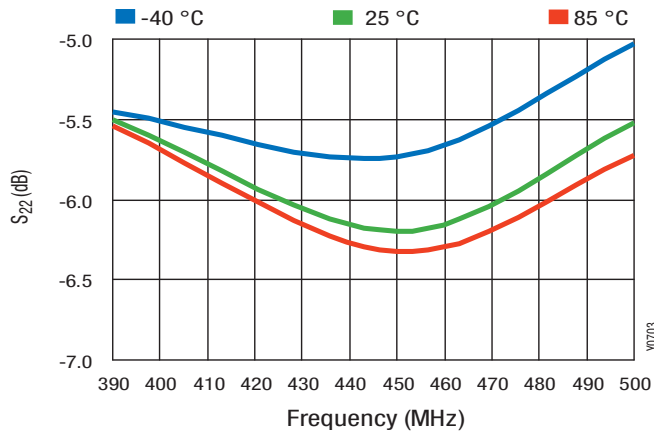

Figure 11. S22 vs Frequency Across Temperature

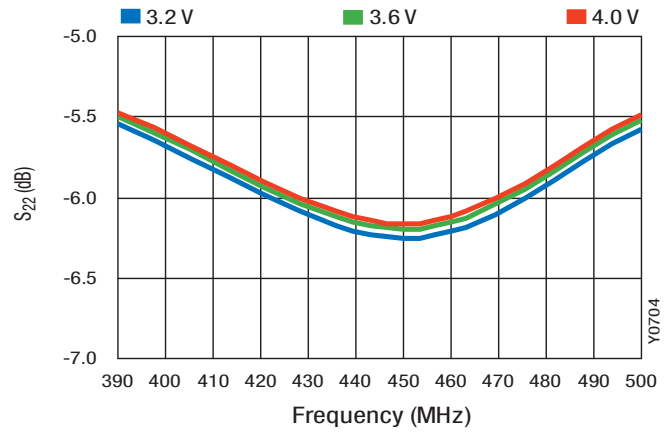

Figure 12. S22 vs Frequency Across VCC

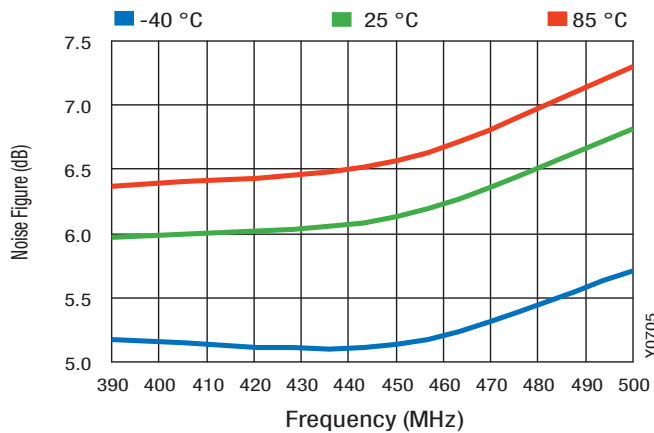

Figure 13. Noise Figure vs Frequency Across Temperature

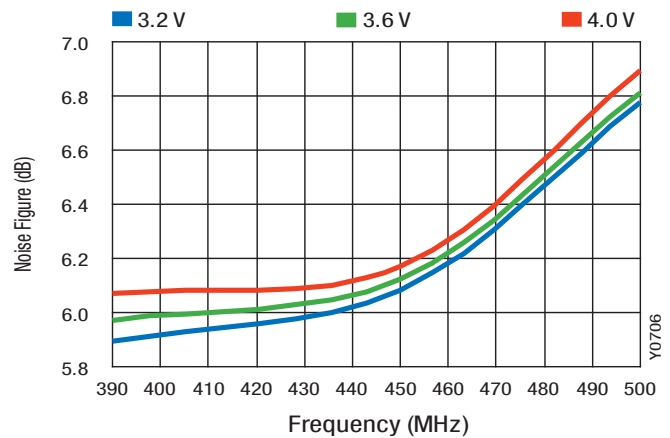

Figure 14. Noise Figure vs Frequency Across VCC

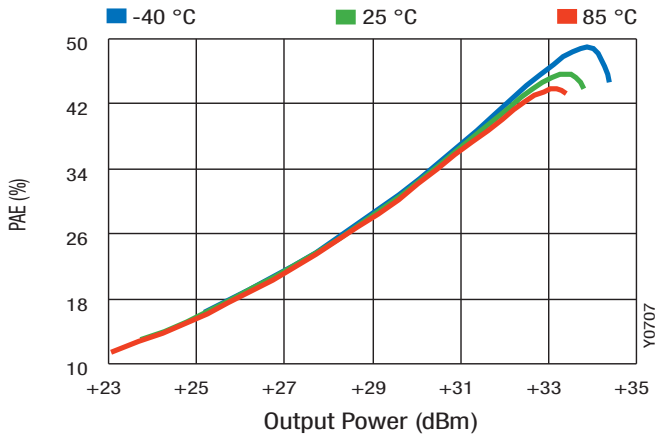

Figure 15. PAE vs Output Power Across Temperature

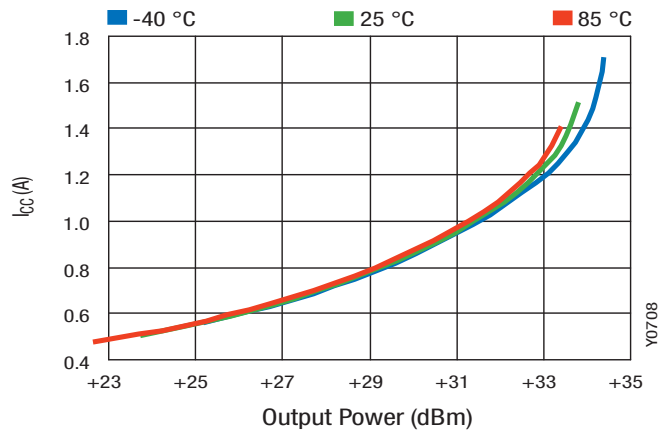

Figure 16. ICC vs Output Power Across Temperature

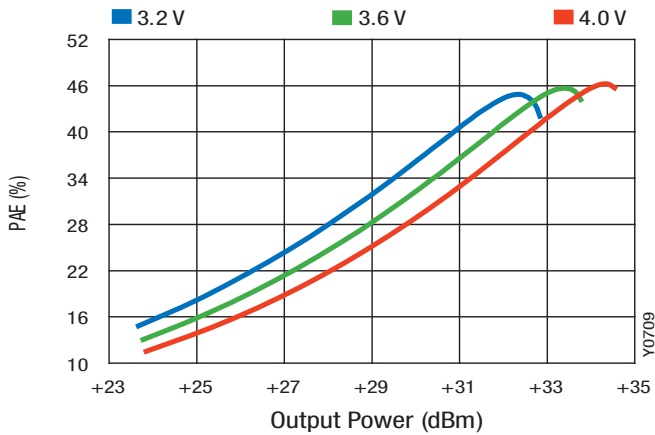

Figure 17. PAE vs Output Power Across VCC

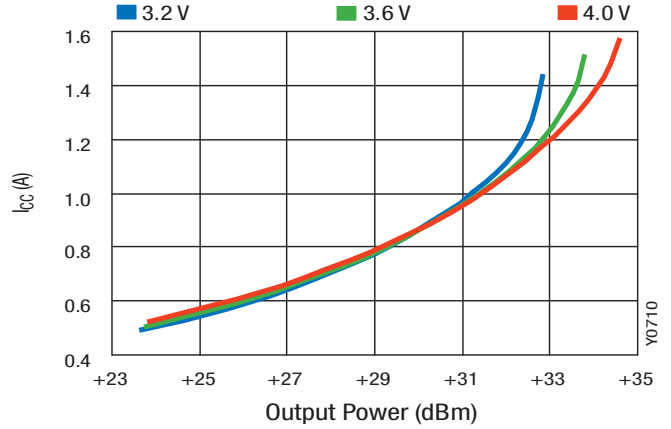

Figure 18. ICC vs Output Power Across VCC

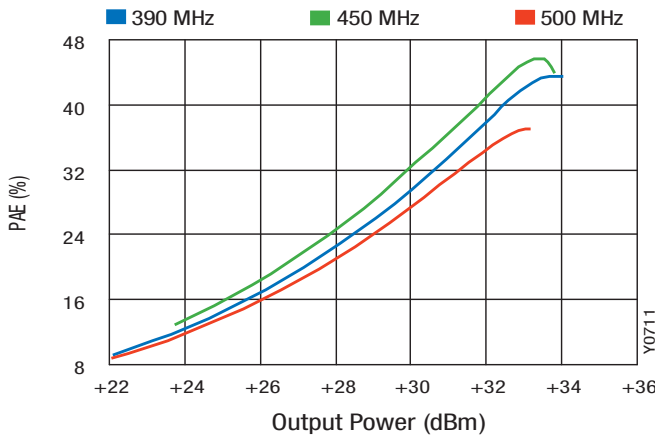

Figure 19. PAE vs Output Power Across Frequency

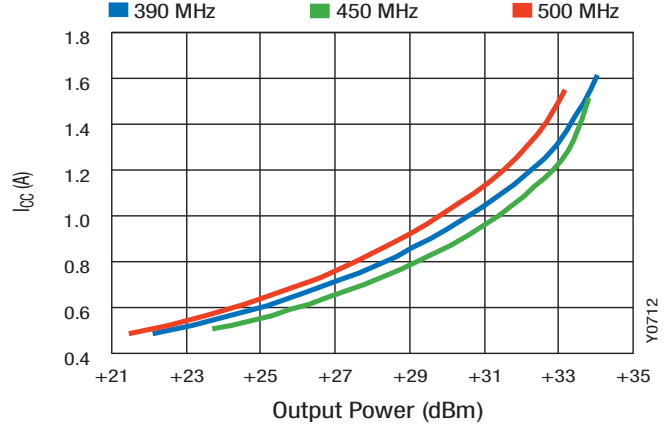

Figure 20. ICC vs Output Power Across Frequency

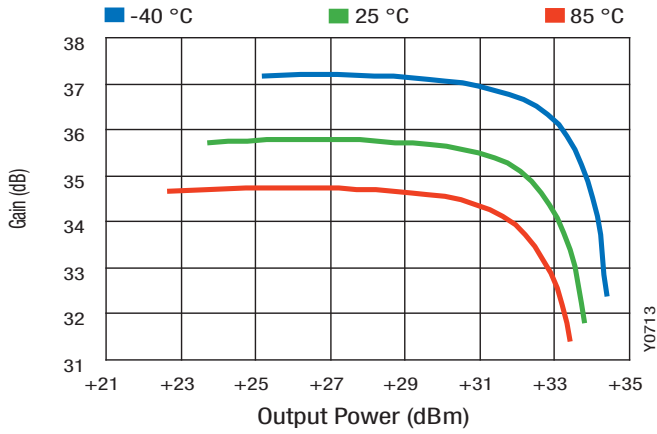

Figure 21. Gain vs Output Power Across Temperature

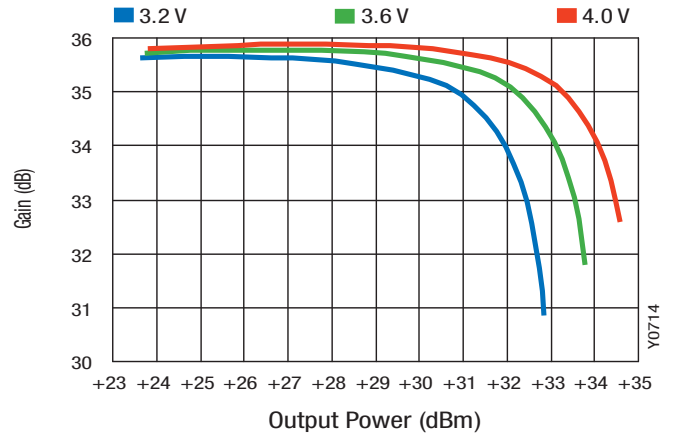

Figure 22. Gain vs Output Power Across VCC

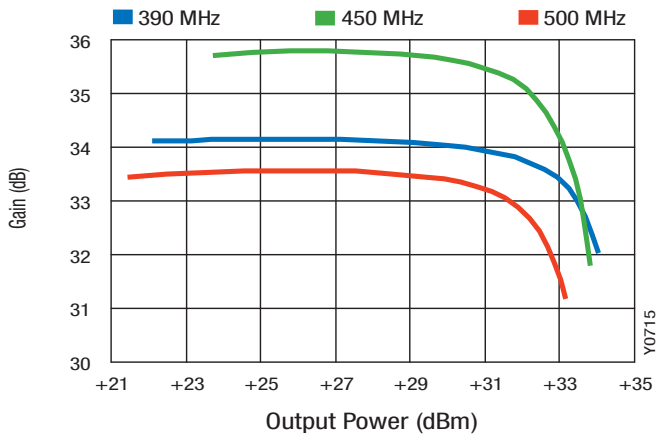

Figure 23. Gain vs Output Power Across Frequency

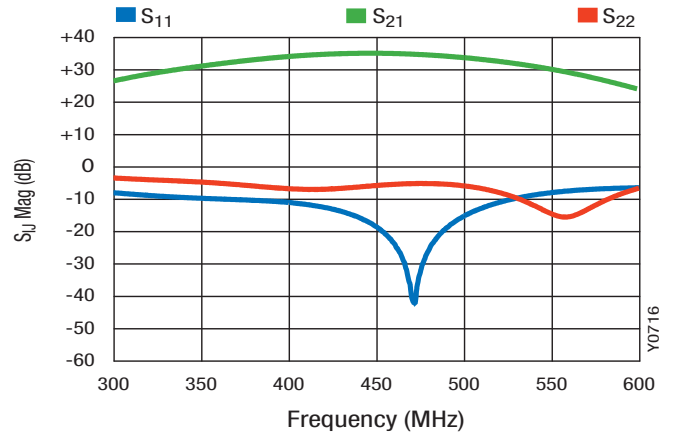

Figure 24. S-Parameters vs Frequency

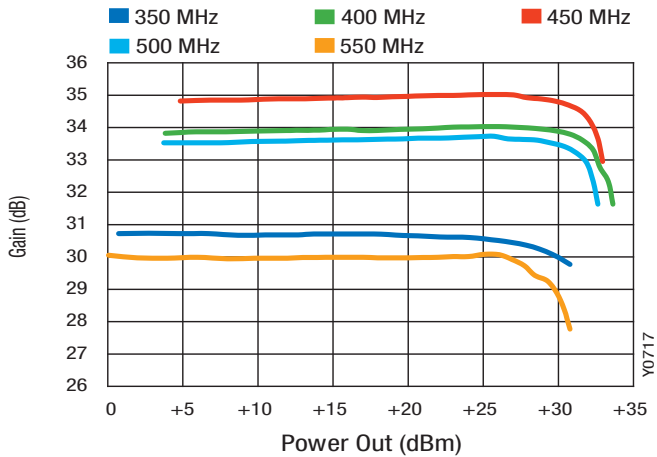

Figure 25. Gain vs CW Power Out

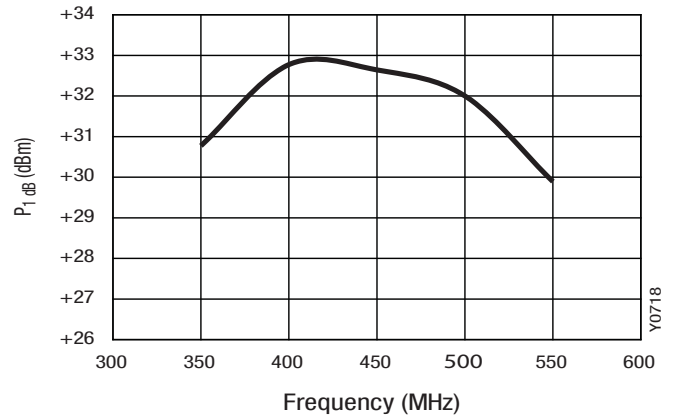

Figure 26. P1dB vs Frequency

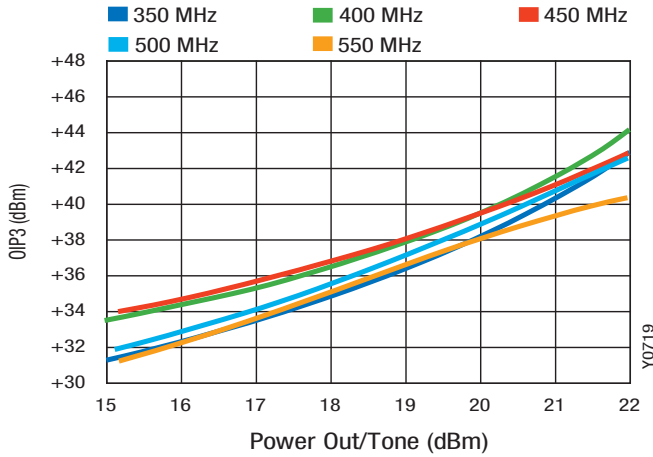

Figure 27. OIP3 vs Output Power/Tone Across Frequency (Tone Spacing = 1 MHz)

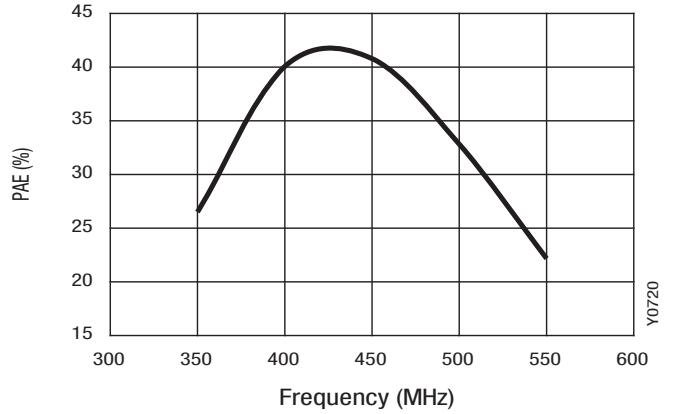

Figure 28. PAE at P1dB vs Frequency

DC/RF Response Time

(VCC1, VCC2, VREF = 3.6 V, VCNT = 0/3.6 V, TA = 25 °C unless otherwise specified)

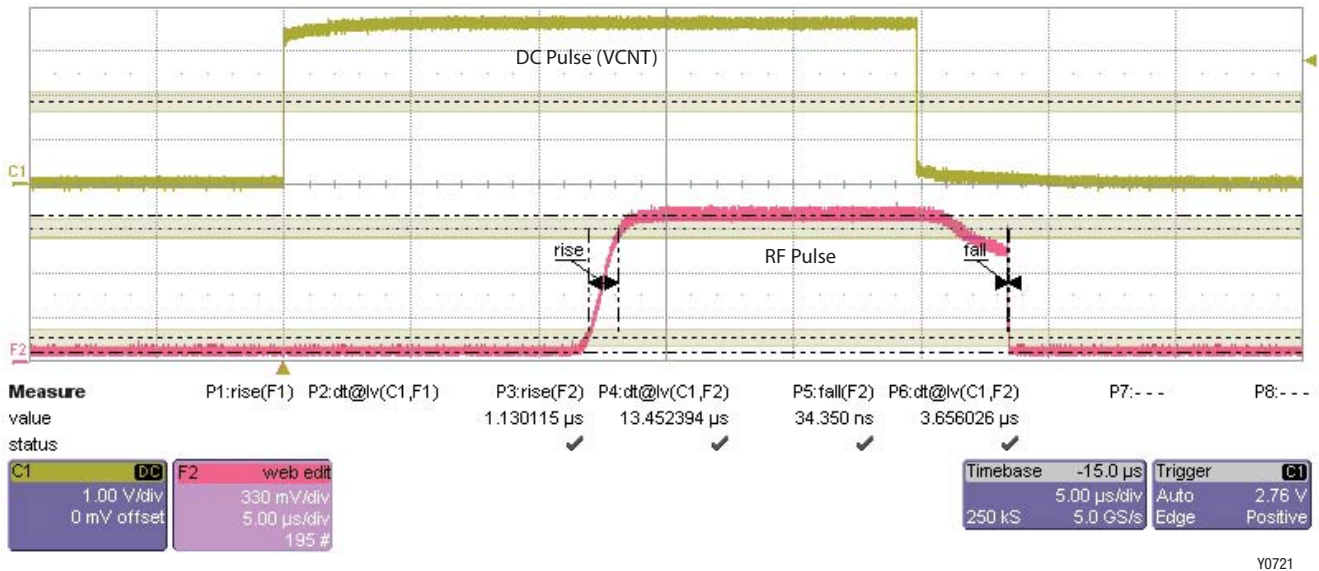

Figure 29. SKY65116 Rise/Fall Times

Table 5. SKY65116 Rise/Fall Times (Note 1)

Pulse	Percent	Label	Rise/Fall	Time
RF-RF	10-90	P3	Rise	1.13 μ s
DC-RF	50-90	P4	Rise	13.45 μ s
RF-RF	90-10	P5	Fall	0.034 μ s
DC-RF	50-10	P6	Fall	3.66 μ s

Note 1: 10 μ F capacitor, C2 and 0.01 μ F capacitor, C5 removed for rise-fall time measurements. Their purpose is to filter DC noise < 200 MHz due to long bias leads to power supply. No noise observed with the removal of C2 and C5.

Theory of Operation

The SKY65116 is comprised of two amplifier stages, and is internally matched for optimum linearity and efficiency. The matching circuits for the input stage, inter-stage, and output stage are contained within the device. An on-chip active bias circuit is included within the device for both input and output stages providing for excellent gain tracking over temperature and voltage variations. The module operates with all positive DC voltages while maintaining high efficiency and good linearity. The nominal operating voltage is 3.6 V for maximum power, but can be operated at slightly lower voltages for other mobile applications.

The input and output stages are independently supplied using the VCC1 and VCC2 supply lines, pins 4 and 10, respectively. The bias reference voltage is supplied using a common VREF (pin 12) line.

The module includes a silicon CMOS controller circuit to provide an amplifier On/Off operation. VCNT (pin 11) is the PA on/off control voltage to the CMOS controller for stages 1 and 2. 0 V = Off, 3.6 V = On. Nominal "On" operating range is between 2.7 to 3.6 VDC. VCNT set to 0 VDC will force the amplifier into off mode, drawing only microamperes of current.

Application Circuit Notes

Center Ground. It is extremely important that the device paddle be sufficiently grounded for both thermal and stability reasons. Multiple small vias are acceptable and will work well under the device if solder migration is an issue.

Ground (Pins 1, 3, 5, 6, 7, 9). Attach all ground pins to the RF ground plane with the largest diameter and lowest inductance via that the layout will allow. Multiple small vias are also acceptable and will work well under the device if solder migration is an issue.

RF_IN (Pin 2). Amplifier RF Input Pin. $Z_0 = 50 \text{ } \Omega$. The module includes an onboard internal DC blocking capacitor. All impedance matching is provided internal to the module.

VCC1 (Pin 4). Supply voltage for the first stage collector bias (typically 3.6 V). Bypassing of VCC1 is accomplished with C7 and C8 and should be placed in the approximate location shown on the evaluation board, but placement is not critical.

RF_OUT (Pin 8). Amplifier RF Output Pin. $Z_0 = 50 \text{ } \Omega$. The module includes an onboard internal DC blocking capacitor. All impedance matching is provided internal to the module.

VCC2 (Pin 10). Supply voltage for the output (final) stage collector bias (typically 3.6 V). Bypassing of VCC2 is accomplished with C1 and C4 and should be placed in the approximate location shown on the evaluation board, but placement is not critical.

VCNT (Pin 11). VCNT is the PA on/off control voltage to the silicon CMOS controller for stages 1 and 2. 0 V = Off, 3.6 V = On. Nominal "On" operating range is between 2.7 to 3.6 VDC. VCNT set to 0 VDC will force the amplifier into standby mode.

VREF (Pin 12). Bias reference voltage for amplifier stages 1 and 2. VREF should be operated over the same voltage range as VCC, with a nominal voltage of 3.6 V.

Package and Handling Information

Since the device package is sensitive to moisture absorption, it is baked and vacuum packed before shipping. Instructions on the shipping container label regarding exposure to moisture after the container seal is broken must be followed. Otherwise, problems related to moisture absorption may occur when the part is subjected to high temperature during solder assembly.

The SKY65116 is rated to Moisture Sensitivity Level 3 (MSL3) at 260 °C. It can be used for lead or lead-free soldering. For additional information, refer to the Skyworks Application Note, Solder Reflow Information, document number 200164.

Care must be taken when attaching this product, whether it is done manually or in a production solder reflow environment. Production quantities of this product are shipped in a standard tape and reel format.

Evaluation Board Description

Skyworks SKY65116 Evaluation Board is used to test the performance of the SKY65116 PA. The Evaluation Board schematic diagram is shown in Figure 30. The schematic shows the basic design of the board for the 390 to 500 MHz range. An assembly drawing for the Evaluation Board is shown in Figure 31 and the layer detail is provided in Figures 32 and 33.

Circuit Design Considerations

The following design considerations are general in nature and must be followed regardless of final use or configuration.

1. Paths to ground should be made as short as possible.
2. The ground pad of the SKY65116 PA has special electrical and thermal grounding requirements. This pad is the main thermal conduit for heat dissipation. Since the circuit board acts as the heat sink, it must shunt as much heat as possible from the amplifier. As such, design the connection to the ground pad to dissipate the maximum wattage produced to the circuit board. Multiple vias to the grounding layer are required.
3. Two external output bypass capacitors (0.01 μF and 10 μF) are required on the VCC1 (pin 4) supply input. The same two capacitors are also required on the VCC2 (pin 10) supply input and on the VREF input (pin 12). Each of these capacitors should be placed in parallel between the supply line and ground. See Figure 30 for a detailed diagram.
4. VCC1 (pin 4) and VCC2 (pin 10) may be connected together at the supply.

NOTE: Junction temperature (T_J) of the device increases with a poor connection to the ground pad and ground. This reduces the life of the device.

Evaluation Board Test Procedure

Use the following procedure to set up the SKY65116 Evaluation Board for testing:

1. Connect a +3.6 V supply to VCC1 and VCC2, and +3.6 V supply to VREF and VCNT. If available, enable the current limiting function of the VCC power supply to 1.5 A.
2. Connect a signal generator to the RF signal input port. Set it to the desired RF frequency at a power level of 2 dBm or less to the Evaluation Board but do NOT enable the RF signal.
3. Connect a spectrum analyzer to the RF signal output port.
4. Enable the power supply.
5. Enable the RF signal.
6. Take measurements.

NOTE: It is important that the VCC1 and VCC2 voltage source be adjusted such that 3.6 V is measured at the board. The high collector currents will drop the collector voltage significantly if long leads are used. Adjust the bias voltage to compensate.

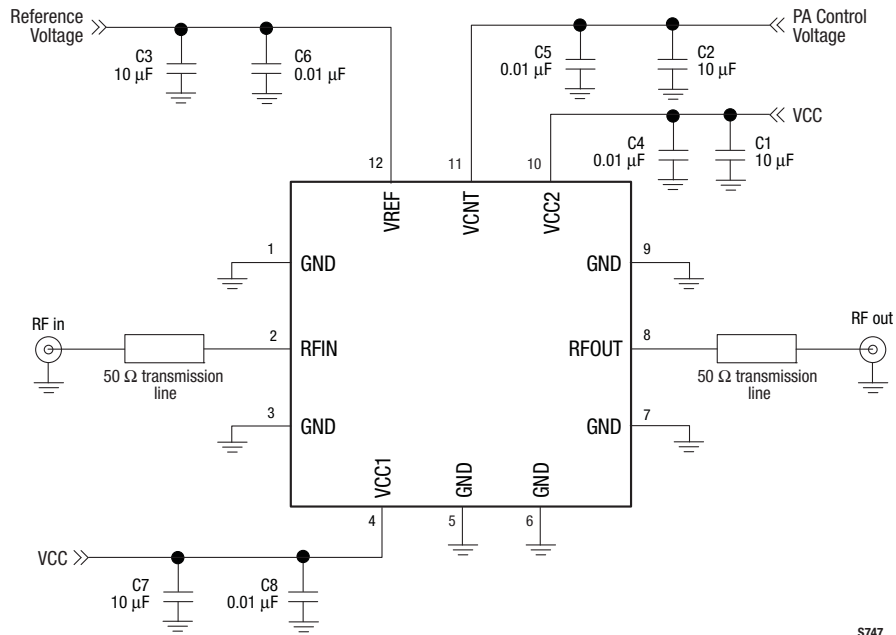

S747

Figure 30. SKY65116 Evaluation Board Schematic

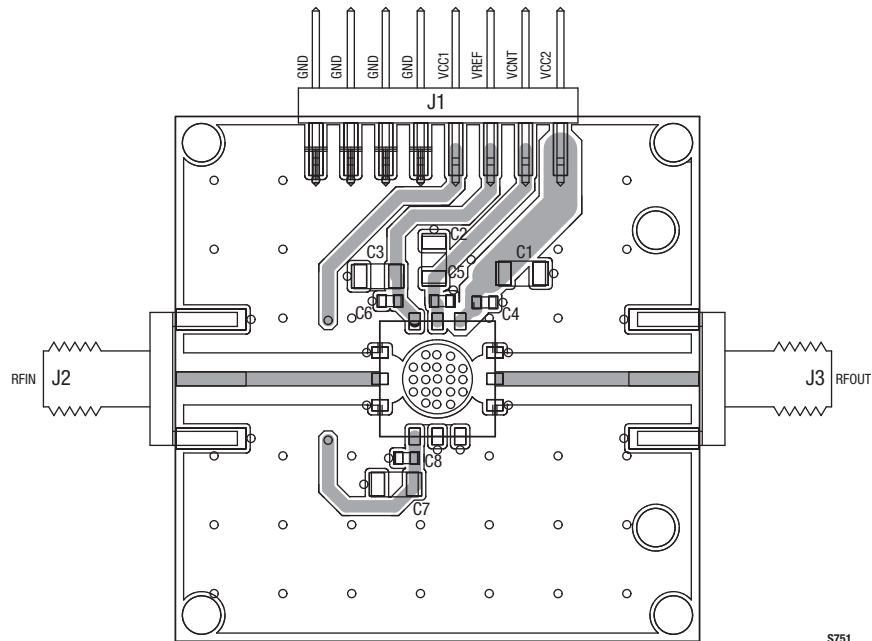

S751

Figure 31. Evaluation Board Assembly Diagram

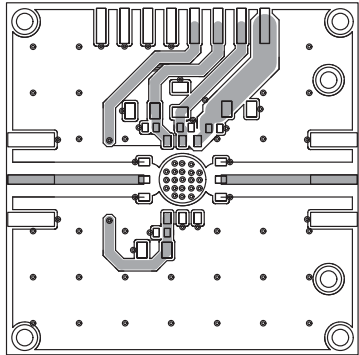

Layer 1: Top -- Metal

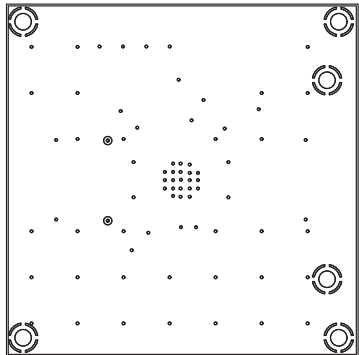

Layer 2: Ground

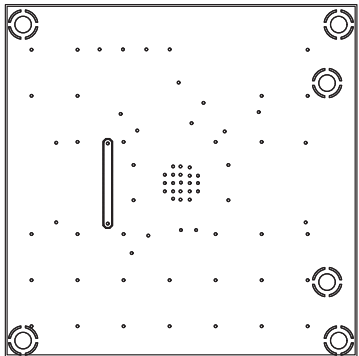

Layer 3: Ground

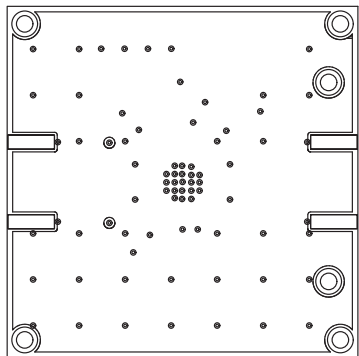

Layer 4: Solid Ground Plane

S752

Figure 32. Evaluation Board Layer Detail

Cross Section	Name	Thickness (mils)	Material	ϵ_r
	L1	1.4	Cu	-
	Lam1	12	Rogers 4003-12	3.38
	L2_GND	1.4	Cu, 1 oz.	-
	Lam2	4	FR4-4	4.35
	L3_GND	1.4	Cu, 1 oz.	-
	Lam3	12	FR4-12	4.35
	L4	1.4	Cu, 1 oz.	-

Y0723

Figure 33. Evaluation Board Layer Detail – Physical Characteristics

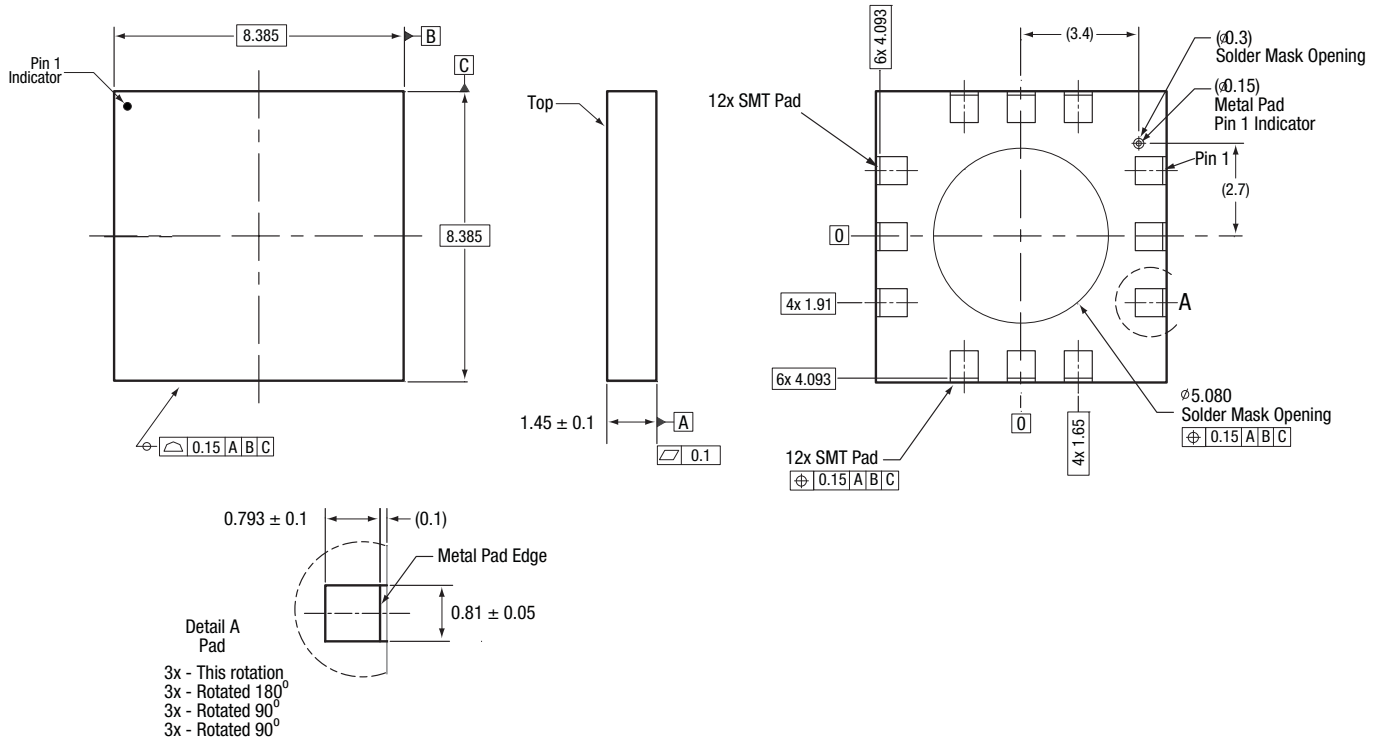

Notes:

1. Dimensions and tolerances in accordance with ASME Y14.5M-1994.
2. All measurements are in millimeters.
3. Pad definitions per details on drawing.

Y0724

Figure 34. SKY65116 12-Pin MCM Package Dimensions

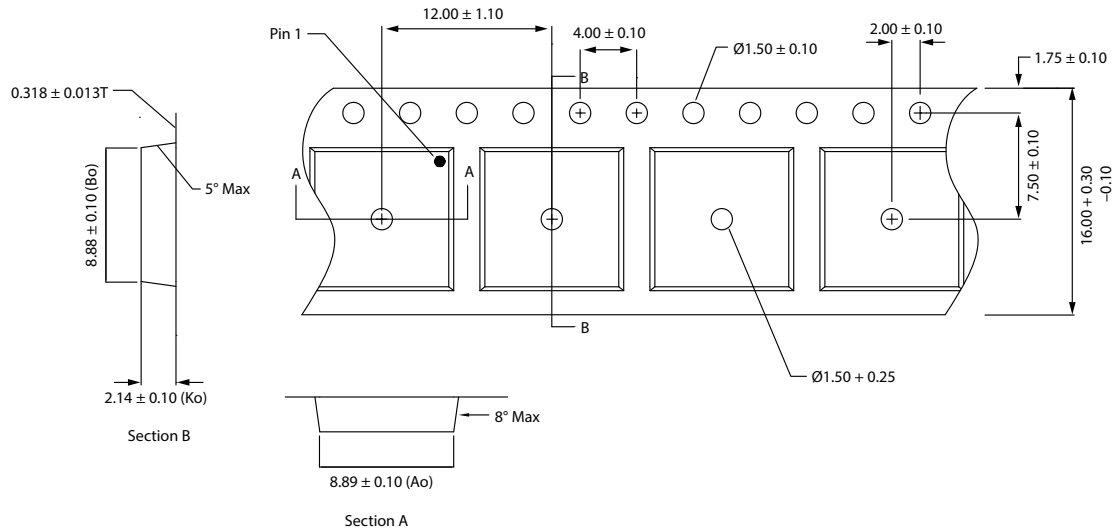

Notes:

1. Carrier tape material: black conductive polycarbonate or polystyrene.
2. Cover tape: transparent conductive pressure sensitive adhesive (PSA) material, 13.3 mm width.
3. ESD-surface resistivity shall be $< / = 1 \times 10^6$ ohms/square per EIA, JEDEC TNR specification.
4. All dimensions are in millimeters

Y0725

Figure 35. SKY65116 12-Pin MCM Tape and Reel Dimensions

Ordering Information

Model Name	Manufacturing Part Number	Evaluation Kit Part Number
SKY65116 390-500 MHz Linear Power Amplifier	SKY65116-21	TW14-D621

Copyright © 2006, 2008-2009, 2014 Skyworks Solutions, Inc. All Rights Reserved.

Information in this document is provided in connection with Skyworks Solutions, Inc. (“Skyworks”) products or services. These materials, including the information contained herein, are provided by Skyworks as a service to its customers and may be used for informational purposes only by the customer. Skyworks assumes no responsibility for errors or omissions in these materials or the information contained herein. Skyworks may change its documentation, products, services, specifications or product descriptions at any time, without notice. Skyworks makes no commitment to update the materials or information and shall have no responsibility whatsoever for conflicts, incompatibilities, or other difficulties arising from any future changes.

No license, whether express, implied, by estoppel or otherwise, is granted to any intellectual property rights by this document. Skyworks assumes no liability for any materials, products or information provided hereunder, including the sale, distribution, reproduction or use of Skyworks products, information or materials, except as may be provided in Skyworks Terms and Conditions of Sale.

THE MATERIALS, PRODUCTS AND INFORMATION ARE PROVIDED “AS IS” WITHOUT WARRANTY OF ANY KIND, WHETHER EXPRESS, IMPLIED, STATUTORY, OR OTHERWISE, INCLUDING FITNESS FOR A PARTICULAR PURPOSE OR USE, MERCHANTABILITY, PERFORMANCE, QUALITY OR NON-INFRINGEMENT OF ANY INTELLECTUAL PROPERTY RIGHT; ALL SUCH WARRANTIES ARE HEREBY EXPRESSLY DISCLAIMED. SKYWORKS DOES NOT WARRANT THE ACCURACY OR COMPLETENESS OF THE INFORMATION, TEXT, GRAPHICS OR OTHER ITEMS CONTAINED WITHIN THESE MATERIALS. SKYWORKS SHALL NOT BE LIABLE FOR ANY DAMAGES, INCLUDING BUT NOT LIMITED TO ANY SPECIAL, INDIRECT, INCIDENTAL, STATUTORY, OR CONSEQUENTIAL DAMAGES, INCLUDING WITHOUT LIMITATION, LOST REVENUES OR LOST PROFITS THAT MAY RESULT FROM THE USE OF THE MATERIALS OR INFORMATION, WHETHER OR NOT THE RECIPIENT OF MATERIALS HAS BEEN ADVISED OF THE POSSIBILITY OF SUCH DAMAGE.

Skyworks products are not intended for use in medical, lifesaving or life-sustaining applications, or other equipment in which the failure of the Skyworks products could lead to personal injury, death, physical or environmental damage. Skyworks customers using or selling Skyworks products for use in such applications do so at their own risk and agree to fully indemnify Skyworks for any damages resulting from such improper use or sale.

Customers are responsible for their products and applications using Skyworks products, which may deviate from published specifications as a result of design defects, errors, or operation of products outside of published parameters or design specifications. Customers should include design and operating safeguards to minimize these and other risks. Skyworks assumes no liability for applications assistance, customer product design, or damage to any equipment resulting from the use of Skyworks products outside of stated published specifications or parameters.

Skyworks, the Skyworks symbol, and “Breakthrough Simplicity” are trademarks or registered trademarks of Skyworks Solutions, Inc., in the United States and other countries. Third-party brands and names are for identification purposes only, and are the property of their respective owners. Additional information, including relevant terms and conditions, posted at www.skyworksinc.com, are incorporated by reference.